

FACTORY 1950

anteprima



foaporte



FACTORY 1950

L'interpretazione dello stile industriale

Our interpretation of industrial style

FOA interpreta in chiave contemporanea lo stile industriale con la collezione **FACTORY 1950**, caratterizzata da un design minimale basato su linee sobrie ed essenziali. Vetro e legno: il progetto e la ricerca stilistica reinterpretano lo stile degli anni cinquanta con l'utilizzo di materiali di alta qualità, naturali, ecologici e riciclabili. Il vetro, da sempre il vero protagonista delle proposte **FOA**, è valorizzato da un sottile perimetro in legno e da profili decorativi orizzontali e verticali, **che permettono di creare modelli con ampi riquadri per conferire luminosità e fascino agli ambienti.**

La precisione nel movimento e la funzionalità degli scorrevoli è garantita dall'utilizzo di **vetri di sicurezza stratificati di spessore 10÷11 mm**, che conferiscono alle ante grande stabilità e robustezza.

L'essenzialità e la varietà dei modelli, realizzati sempre "su misura", permettono ampia libertà di progettare soluzioni sempre nuove e differenti, combinando una gamma di nuove finiture esclusive con le numerose tipologie di vetri proposte, in diverse trasparenze e colorazioni.

Presentiamo in questa **ANTEPRIMA** alcune proposte che anticipano le potenzialità offerte dalla collezione **FACTORY** per soluzioni d'arredo che interpretano, **con un'impronta minimale e rigorosa, l'attuale concezione del vivere tutti i luoghi della nostra vita quotidiana.**

FOA reinterprets the industrial style following the contemporary sensibilities with its **FACTORY 1950** collection, featuring minimalist design, based on essential and simple lines.

Glass and wood: our project and research reinterpret the style of the 1950s, using high-quality, ecological and recyclable materials. Glass, the true protagonist of **FOA** products since their inception, is enhanced by a lithe wooden framework and by horizontal and vertical decorations, **allowing the creation of models featuring wide decorations giving light and charm to any living space.**

The precision our doors have in their movement and the functioning of their sliding elements is warranted by **the use of 10÷11 mm thick laminated safety glass**, giving their shutters a significant stability and resilience. The essentiality and variety of our models, always "tailor-made" following the needs of our customers, allow a significant degree of liberty in constantly designing new and different solutions, combining our exclusive finishing with the many kinds of glass we propose, available in several different transparencies and colours. In this **PREVIEW** of ours, we present to you some of the proposals describing the potential of our **FACTORY** collection. This collection offers solutions for home furnishings interpreting, **with originality, minimalism and rigour, the most advanced conceptions on living all our daily spaces.**

Made in Italy



01

mod. TV 4

Sistema scorrevole con binario per controsoffitto
Sliding system with rail for false ceilings

TRASPARENTE EXTRACHIARO

Vetro stratificato 10÷11
Laminated glass 10÷11

TOTAL BLACK

Finitura / Finishing

mod. TV 2

Sistema scorrevole con binario per controsoffitto
Sliding system with rail for false ceilings

TRASPARENTE EXTRACHIARO

Vetro stratificato 10÷11
Laminated glass 10÷11

CANNETÉ

Decoro "vetro liquido trasparente"
"Vetro liquido trasparente" decoration

RAME

Finitura / Finishing



02

03

mod. T4

Sistema scorrevole con binario per controsoffitto
Sliding system with rail for false ceilings

TRASPARENTE EXTRACHIARO

Vetro stratificato 10÷11
Laminated glass 10÷11

TOTAL BLACK

Finitura / Finishing

04



mod. T1

Sistema scorrevole con binario per controsoffitto
Sliding system with rail for false ceilings

TRASPARENTE EXTRACHIARO
Vetro stratificato 10÷11
Laminated glass 10÷11

GALLES texture
Decoro acidato su entrambi i lati
Etched decoration on both sides

TOTAL BROWN
Finitura / Finishing

05



mod. TV 5

Divisorio fisso / Fixed partition

TRASPARENTE EXTRACHIARO
Vetro stratificato 10÷11
Laminated glass 10÷11

TOTAL BLACK
Finitura / Finishing

06

mod. T3

Sistema scorrevole con binario per controsoffitto
Sliding system with rail for false ceilings

TRASPARENTE EXTRACHIARO

Vetro stratificato 10÷11
Laminated glass 10÷11

CANNETÉ

Decoro "vetro liquido trasparente"
"Vetro liquido trasparente" decoration

BRONZO

Finitura / Finishing

Modelli / Models

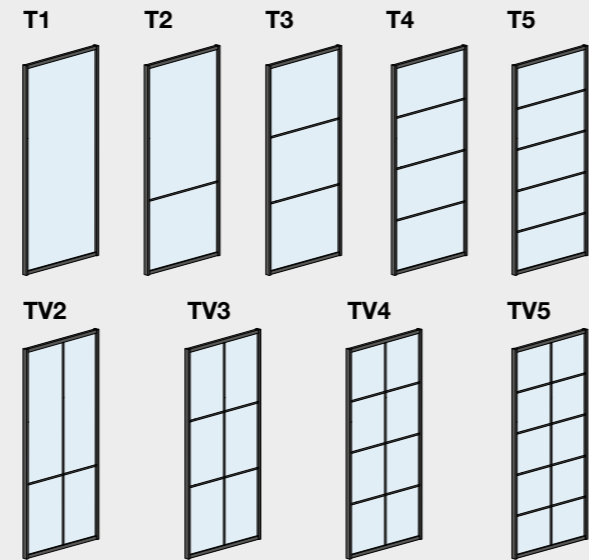
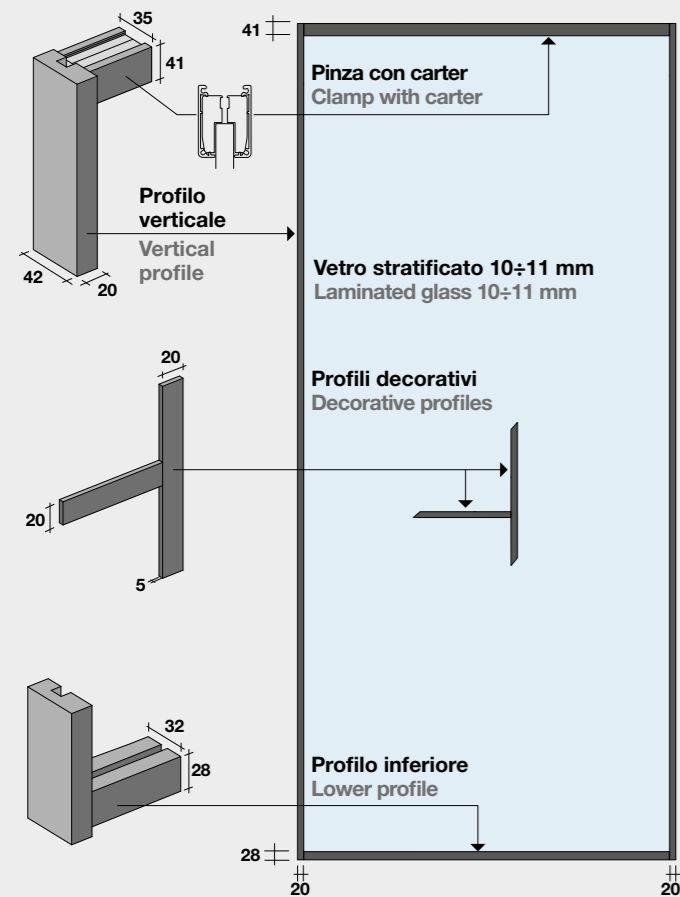

* Posizione prevista per decoro "vetro liquido trasparente" CANNETÉ
Expected positions for decoration CANNETÉ

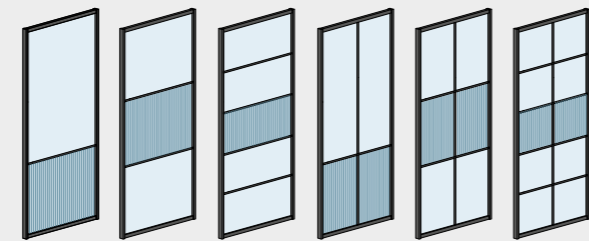

Travi di scorrimento / Ceiling door head

Travi a soffitto - Ceiling door head

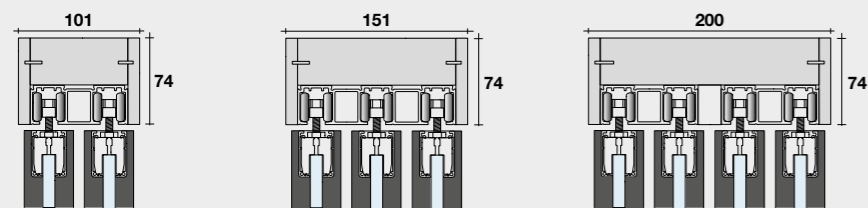

Travi per controsoffitto - False installation door head

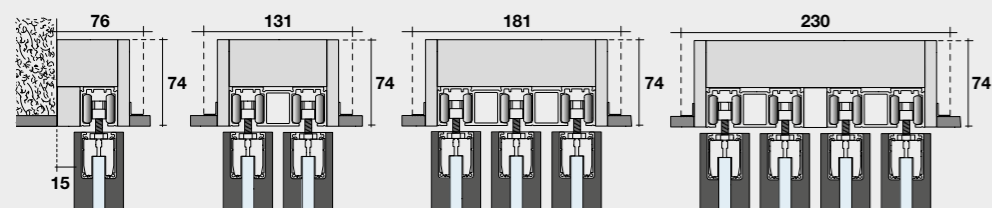

Travi a parete - Wall installation door head

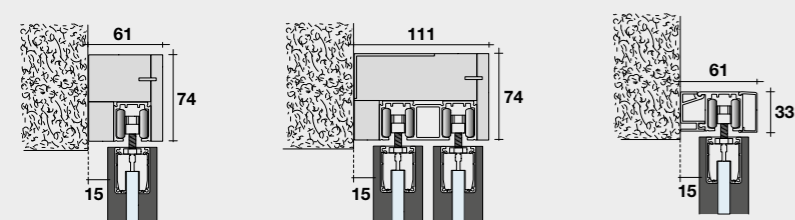

Sistemi scorrevoli Sliding system

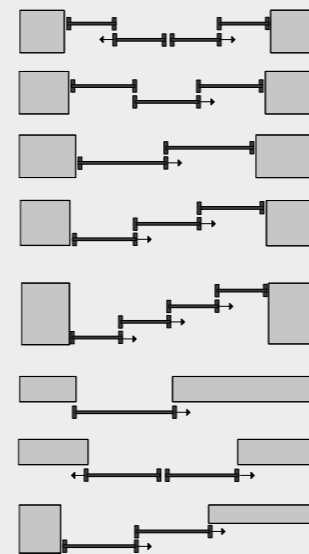

Sistemi a scomparsa Concealed-in-wall sliding systems

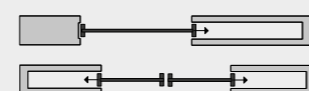

Finiture / Finishes

TOTAL BLACK



TOTAL WHITE



TOTAL WHITE 9010



TOTAL BROWN



BRONZO



RAME



ALLUMINIO



TITANIO



CORTEN



CORTEN E RAL = FINITURE SU RICHIESTA / FINISHES ON REQUEST

Maniglie / Handles

Le maniglie sono fornite nella stessa finitura dell'anta e sono comprese nel prezzo

The handles are supplied in the same finish as the door and are included in the price

C/20

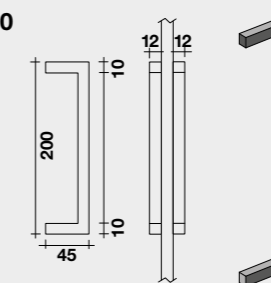

Vetri / Glasses

TRASPARENTI: Trasparente - Trasparente extrachiaro - Bronzo - Fumé
SATINATI: Acidato - Acidato extrachiaro - Serie BLUES
SEMIRIFLETTENTI TRASPARENTI: SUPERSILVER Chiaro, Bronzo, Fumé, Golden
SEMIRIFLETTENTI SATINATI: SUPERSILVER Chiaro, Bronzo, Fumé, Golden
SPECCHI BIFACCIALI: Specchio bifacciale - EXTRAMIRROR Chiaro, Bronzo, Fumé
VETRI ARGENTATI BIFACCIALI SATINATI: SOFTMIRROR Chiaro, Bronzo, Fumé
VETRI COLORATI EFFETTO SATINATO: Serie RAP
VETRI COLORATI COPRENTI: Serie SONG - Serie RAL
VETRI TESSUTO: Serie FLOU - Serie FOLK

Decorati / Decoration

DECORI ACIDATI:
Texture GALLES e MACRAMÉ
DECORI "VETRO LIQUIDO":
CANNETÉ - solo nelle posizioni previste *
in the expected positions only *
Altri decori: solo modello T1
Other decorations: model T1 only
DECORI SABBATI
SANDBLASTED DECORATION:
Solo modello T1 / Model T1 only



foaporte

FOA srl

Via Rosa Augusto, 20
43038 Sala Baganza
(Parma) - Italia

T +39 0521 836336
F +39 0521 836301

www.foaporte.it
info@foaporte.it